

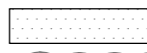









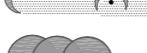
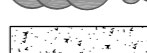
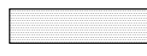

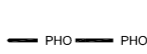



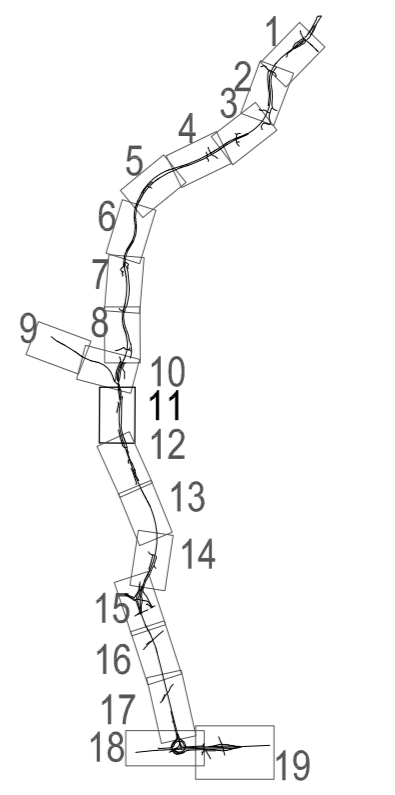













**ZASNOVA KRAJINSKE UREDITVE**

-  obstoječe gozdne površine
-  obstoječa vegetacija ob trasi, ki se ohranja
-  površinske zasaditve, gozdni robovi
-  posamične zasaditve
-  rekultivacije
-  nove zatratitve
-  oblikovanje reliefa
-  oblikovanje zidov
-  PH nasipi
-  PH ograje
-  meja DPN

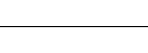

- LEGENDA**
-  Projektirana cesta
  -  Projektirana cesta z zelenjavo
  -  Projektirana cesta z drevesi
  -  Obstoječi NN vod
  -  Projektirani SN vod
  -  Obstoječi SN vod
  -  Projektirani VN vod
  -  Obstoječi VN vod
  -  Projektirani vodovod
  -  Obstoječi vodovod
  -  Projektirani kabelsko razdelilni sistem
  -  Obstoječ kabelsko razdelilni sistem
  -  Projektirani Klic v sili
  -  Projektirana odpadna kanalizacija
  -  Obstoječa odpadna kanalizacija
  -  Projektirana meteorna kanalizacija
  -  Obstoječa meteorna kanalizacija
  -  Projektirana mešana kanalizacija
  -  Obstoječa mešana kanalizacija
  -  Projektirani plinovod
  -  Obstoječi plinovod
  -  Odstranitev komunalnih vodov
  -  VN steber
  -  Transformatorska postaja

investitor:	<b>DARS</b> Povezujemo Slovstvo	cesta:	DC DRAVOGRAD - ŠENTRUPERT
projektant:	<b>pnz</b> PNZ inženiring projekcije	odsek:	VELENJE - ŠENTRUPERT (SKLOP1)
projektant načrta:	Maja Vodnik krajinska arhitektura	projekt:	3. razvojna os: VELENJE - ŠENTRUPERT
		objekt:	DRŽAVNA CESTA
		načrt:	Načrt krajinske arhitekture
		rišab:	zasnova krajinske ureditve od km 7.35 do 8.25
odg. vodja proj.: Andrej Jan, univ.dipl.inž.gr., G-2130		proj. inšp.: Maja Vodnik, univ.dipl.inž.arh., 0927 KA	vrsta projekta: ena od vrst, ki se ohranja, št. projekta: 11-0334, št. načrta: KA-102
odg. projektant: Maja Vodnik, univ.dipl.inž.arh., 0927 KA		proj. inšp.: Maja Vodnik, univ.dipl.inž.arh., 0927 KA	klas. oznaka: 2110, št. nabe: 2/1.8.15
projektant: Rok Cunder, univ.dipl.inž.gr.		proj. inšp.: Maja Vodnik, univ.dipl.inž.arh., 0927 KA	datum: junij 2010
revizije:			
sprememba: opis spremembe:		sklepi, opombe:	datum: junij 2010
01 DOPOLNENJE PO JAVNI RAZPISNI IN REZENCIJAH			
02			
šifra odseka:	arhivska številka:	vrsta dokumentacije:	šifra priloge:
	001.2110	G.120.11	

